



Quimatic
Especialidades químicas que transformam



FIXOFLEX

ACESSÓRIOS E DISPOSITIVOS
PARA **USINAGEM**

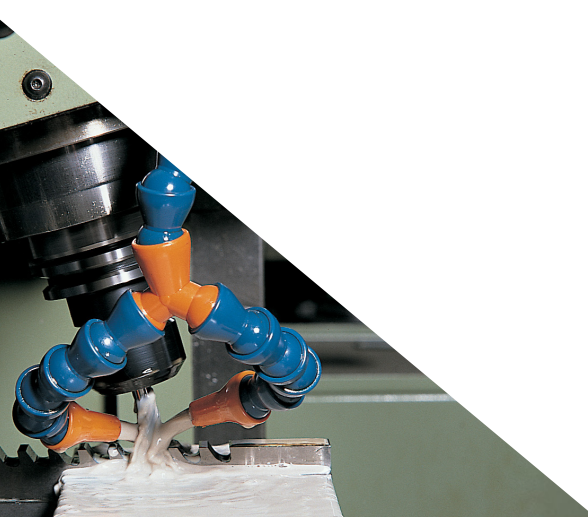



FIXOFLEX - Original

Sistema de tubos flexíveis, ajustáveis, para aplicação de óleo solúvel. É fornecido em jogos de bicos, terminais e elos de tubos. As peças com simples encaixe possibilitam mais de 2mil combinações.

- Resiste à vibração e manuseio.
- Fluxo ininterrupto em qualquer posição.
- Alta resistência a produtos químicos.
- Imune à corrosão.
- Não condutor elétrico. Ideal para usinagem por descarga elétrica.



Facilmente encaixável



Adaptável a diferentes tamanhos



Adaptável a diferentes combinações entre sistemas

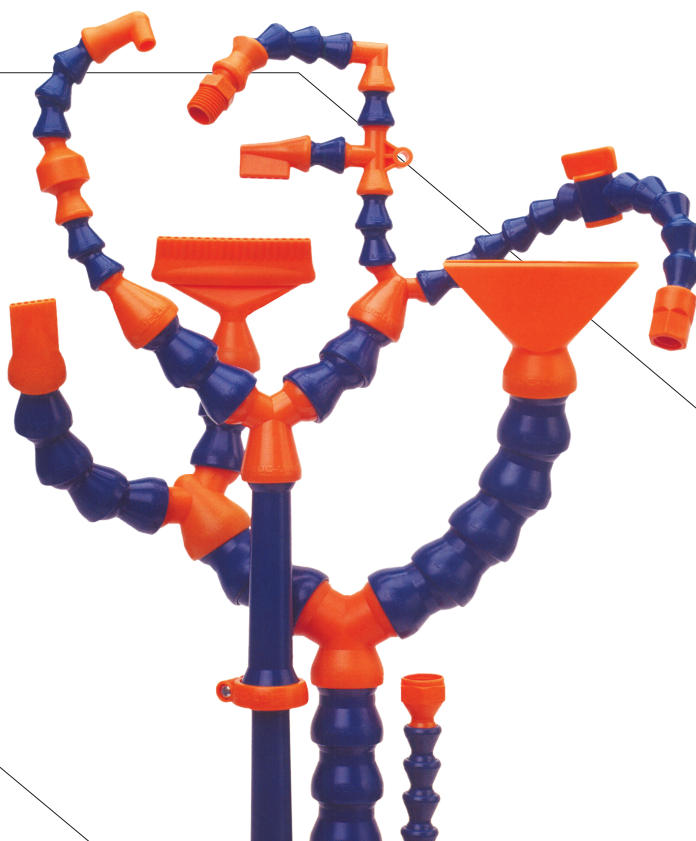
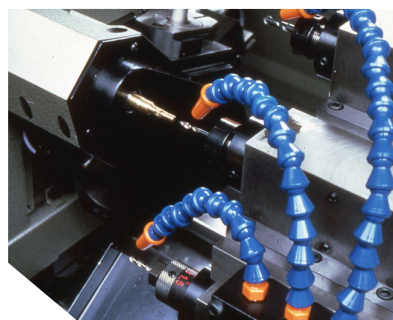



MEDIDAS DO ELO DO SISTEMA Ø 1/4"

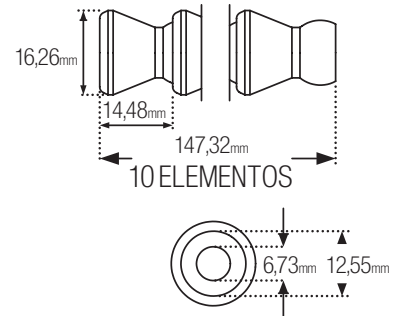

1/4" - 6,35 mm - Ø INTERNO

1-A/K - JOGO ESPECIAL



1-MET- JOGO BÁSICO COM BICO METÁLICO

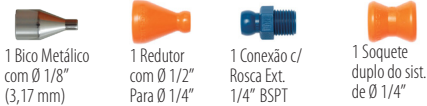

1-A - SUPER JOGO

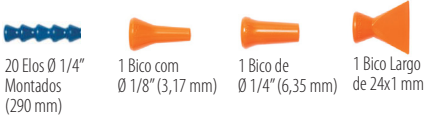

2-A - SUPER JOGO ELOS DE TUBO



3-A - SUPER JOGO BICOS REDONDOS



3-A/C - JOGO ESPECIAL

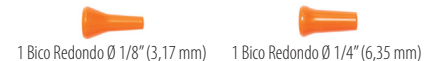

4-A - SUPER JOGO CONEXÕES



5-A - JOGO CONEXÃO "Y"

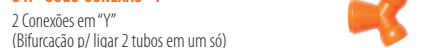

6-A - TORNEIRA COM ENCAIXE RÁPIDO



7-A - BICO LARGO



8-A - ALICATE PARA MONTAR/DESMONTAR



9-A - BICO LARGO TIPO CHUVEIRO



10-A - JOGO SISTEMA DE BICOS COM JATO LAT. E APLICAÇÃO CIRCULAR



11-A - COTOVELO



12-A - BICO E INCLINAÇÃO Ø 1/8"



13-A - BICO E INCLINAÇÃO Ø 1/4"



14-A - BICO LARGO TIPO CHUVEIRO



15-A - CONEXÃO ROSCA EXTERNA



16-A - CONEXÃO ROSCA INTERNA



17-A - CONEXÃO ROSCA EXTERNA NPT



18-A - JOGO COM BICO METÁLICO



19-A - SOQUETE DUPLO



21-A - TORNEIRA COM ROSCA



22-A - ADAPTADOR ROSCA INTERNA



23-A - ROSCA EXTERNA NPT



24-A - ROSCA EXTERNA BSPT



26-A - JOGO SIMPLES MONTADO



1/2" - 12,70 MM - Ø INTERNO

3/4" - 19,05 MM - Ø INTERNO



MEDIDAS DO ELO DO SISTEMA Ø 1/2"

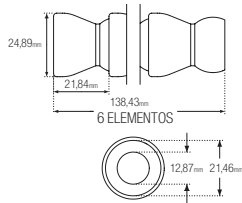

MEDIDAS DO ELO DO SISTEMA Ø 3/4"

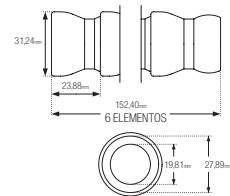

1-L - JOGO DO SISTEMA DE Ø 1/2"

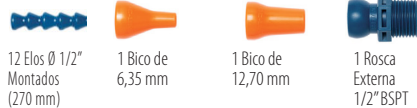

12 Elos Ø 1/2"
Montados
(270 mm)

1 Bico de
6,35 mm

1 Bico de
12,70 mm

1 Rosca
Externa
1/2" BSPT

9-L - TORNEIRA

1 Torneira de Encaixe Rápido para Sistema Ø 1/2"



10-L - ALICATE PARA MONTAR/DESMONTAR

1 Alicete para Sistema Ø 1/2"



1-M - JOGO BÁSICO

12 Elos Ø 3/4"
(294 mm)



1 Bico redondo de Ø 5/8"
1 Bico redondo de Ø 3/4"

1 Conexão com Rosca
Externa de 3/4" BSPT

2-M - JOGO ELOS DE TUBO

6 Elos para Sistema de Ø 3/4" (153 mm)



3-M - JOGO BICOS REDONDOS Ø 3/4"

2 Bicos redondos de Ø 3/4"



4-M - JOGO BICOS REDONDOS Ø 5/8"

2 Bicos redondos de Ø 5/8"



5-M - CONEXÃO "Y"

1 Conexão "Y" Ø 3/4" para bifurcação



6-M - BICO LARGO

1 Bico Largo (76x5 mm) para Sistema de Ø 3/4"



7-M - REDUTOR Ø 3/4" PARA Ø 1/2"

1 Redutor de Ø 3/4" para Sistema de Ø 1/2"



8-M - CONEXÃO ROSCA EXTERNA

1 Conexão com Rosca Externa 3/4" BSPT



9-M - JOGO PROTETOR (Transparente)

Escudo de Proteção com Base Magnética para Sistema de Ø 3/4"



10-M - REDUTOR EM "Y"

1 Redutor em "Y" de Ø 3/4" para Sistema de Ø 1/2"



2-L - JOGO DE ELOS DE TUBO

6 Elos de Ø 1/2" (140 mm)



3-L - JOGO BICOS REDONDOS

2 Bicos redondos Ø 1/2"



4-L - JOGO BICOS REDONDOS

2 Bicos redondos Ø 1/4"



5-L - CONEXÃO "Y"

1 conexão "y" Ø 1/2" p/ bifurcação



6-L - BICO LARGO

1 Bico largo de 62x3 mm para Sistema de Ø 1/2"



7-L - JOGO REDUTORES Ø 1/2" Ø 1/4"

2 Redutores de Ø 1/2" para Ø 1/4"



8-L - CONEXÃO ROSCA EXTERNA

1 Conexão Rosca Externa 1/2" BSPT



11-L - BICO LARGO

1 Bico largo de 1.1/4" para Sistema Ø 1/2"



12-L - JOGO COM BICO DE APLICAÇÃO CIRCULAR

15 Bicos com furos de Ø 0.140"



13-L - ELO TIPO COTOVELO

1 Elo tipo Cotovelo a 90° para Sistema Ø 1/2"



14-L - BICO LARGO TIPO CHUVEIRO

1 Bico largo tipo chuveiro a 90° (com 8 Furos) para Sistema Ø 1/2"



15-L - BICO REDONDO Ø 3/8"

1 Bico redondo Ø 3/8" a 90° para Sistema Ø 1/2"



16-L - BICO REDONDO Ø 1/2"

1 Bico Redondo Ø 1/2" a 90° para Sistema Ø 1/2"



17-L - CONEXÃO ROSCA EXTERNA 1/2"

Conexão Rosca Externa 1/2" NPT para Sistema Ø 1/2"



18-L - CONEXÃO ROSCA EXTERNA 3/8" NPT

1 Conexão Rosca Externa 3/8" NPT para Sistema Ø 1/2"



19-L - CONEXÃO ROSCA EXTERNA 3/8" BSPT

1 Conexão Rosca Externa 3/8" BSPT para Sistema Ø 1/2"



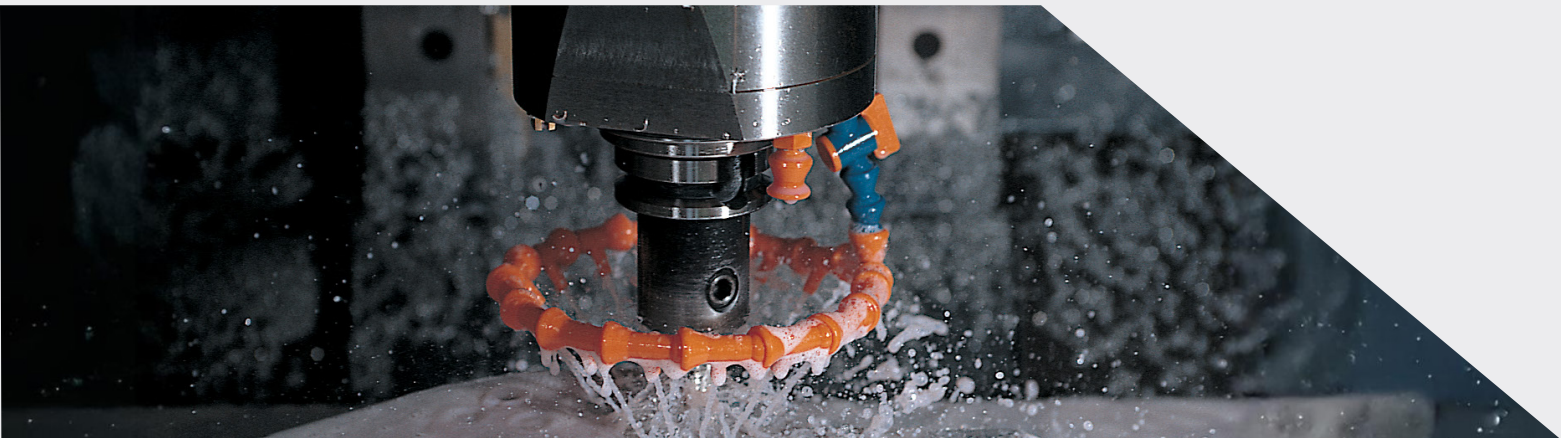
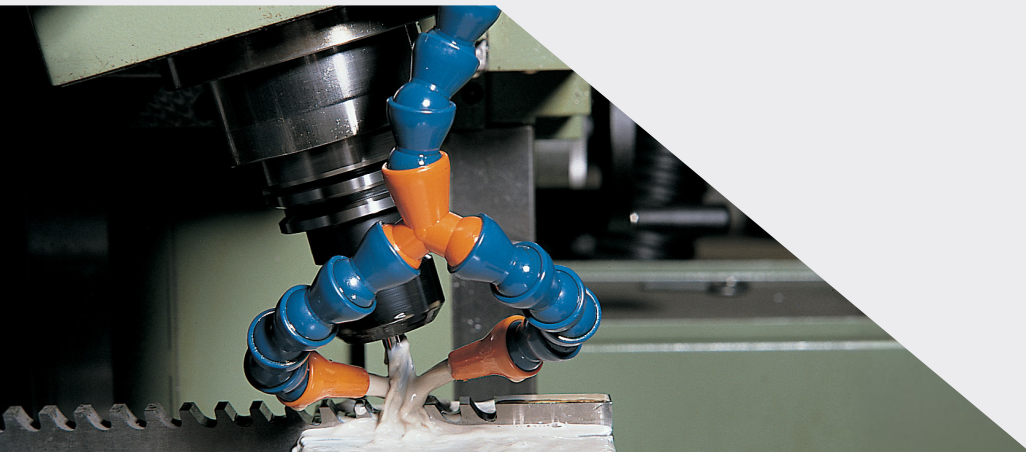

Quimatic

TAPMATIC DO BRASIL INDÚSTRIA E COMÉRCIO LTDA. Empresa certificada ISO 9001
Indústria Brasileira – R. Salesópolis, 16 – 06409-150 – BARUERI – SP
CNPJ: 44.769.321/0001-20
SAC: (11) 3312-9999 – E-mail: sac@quimatic.com.br
Site: www.quimatic.com.br



ACESSE O SITE

